

Data Sheet



Article number: 51503547160010

Description: Vibration damper GP-1I 160x125
M16, NR shore 57

Measures

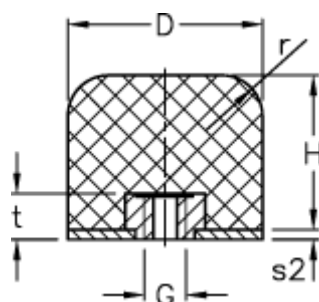

D	= 160	t = 16
d2	= 6	
G	= M16	
H	= 125	
Load capacity F (kN)	= 240.0	
Load capacity f (mm)	= 68	
Load capacity W (J)	= 4400	
r	= 32.0	